



## EzeeStat II Multi-Function Programmable Thermostat

### INDEX

A. INTRODUCTION .....	1
B. CHOOSING THE CORRECT LOCATION.....	1
C. INSTALLATION .....	1
D. SETTING THE MODE OF OPERATION .....	1
E. SET/MODIFY THE 'INTERNAL SETTINGS'.....	2
F. SET/ADJUST THE CLOCK.....	2
G. SET/ADJUST THE REQUIRED SETPOINTS FOR COMFORT AND ECONOMY.....	2
H. SET/ADJUST THE PROGRAMMING.....	3
I. PROGRAM OVERRIDES.....	3
J. CONNECTION DIAGRAMS.....	3
K. SPECIFICATIONS.....	4
L. CONTENTS.....	4

### A. INTRODUCTION

This thermostat can be operated in one of 3 modes:

- 1. Room temperature control (Room mode)**  
The thermostat controls the room temperature by switching the heating or cooling system.
- 2. Floor temperature control (Floor mode)**  
The thermostat controls the floor temperature (Floor heating only).
- 3. Room temperature control + Floor limitation (Room + Floor mode)**  
Room temperature governs the heating whilst limiting the floor to a set maximum temperature. (Floor heating with sensitive flooring - e.g. vinyl, wood).

Mode selection is done by setting jumpers on the printed circuit board. (refer to section D)

### B. CHOOSING THE CORRECT LOCATION.

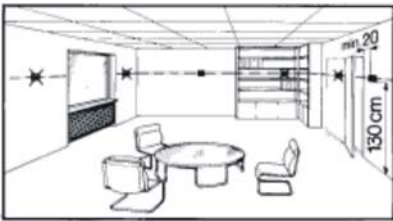

The thermostat must be located in the room where the heating/cooling is to be controlled, except in the case of floor temperature control (mode 2).

The position should be chosen so that the sensor can measure the room temperature as accurately as possible. Direct solar radiation, drafts as well as other heating or cooling sources must be avoided.

The mounting height should be approximate 1.3 metres.

The unit can be fitted to either a 3"x3" or 2"x4" horizontal recessed conduit box or directly onto the wall.

### C. INSTALLATION

#### 1. Opening the thermostat housing

The plastic enclosure consists of 2 parts, front and base, which are connected by means of a hinge. (A small "\*" screw-driver is required)

STEP 1.  
Loosen the fastening screw

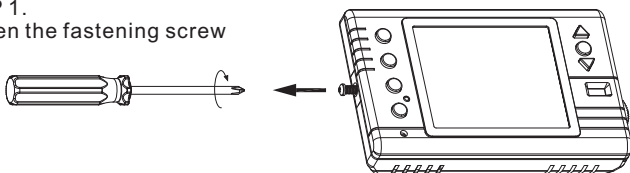

STEP 2.  
Open the unit. Press and hold both sides of the protective terminal cover and pull it off the thermostat base.

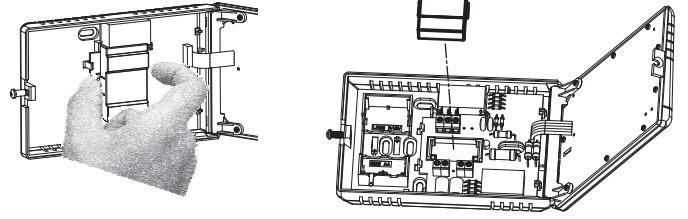

STEP 3.  
Mount the unit to the wall with the mounting screws provided.

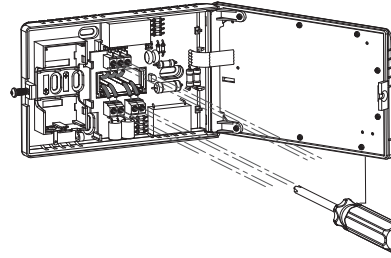

STEP 4.  
Connect the electric wires /Floor sensor cable to the correct terminals (refer to section I).

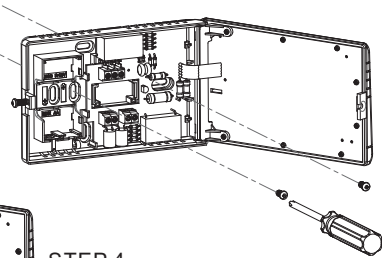

STEP 5.  
Press and hold both sides of the terminal cover and fit it back onto the base.

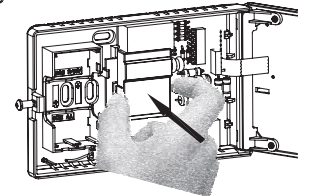

STEP 6.  
Remove the backup battery's insulation foil by pulling the tab.

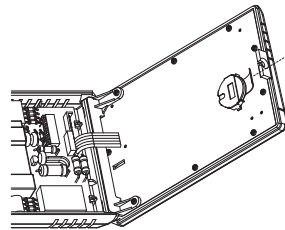

If the tab is not pulled out, the time will not be maintained in the event of a power outage.



STEP 7.  
Close the unit and tighten the screw.

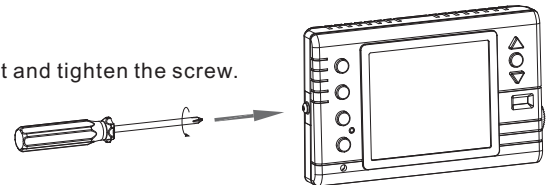

### D. SETTING THE MODE OF OPERATION

Locate the jumpers, they can be found on the right hand side of the top printed circuit board.

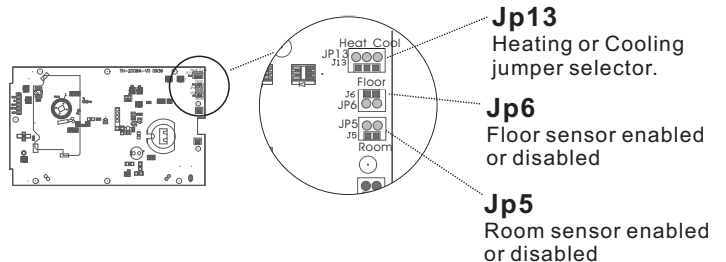





EFF

If the mode of operation is set incorrectly (e.g. Cooling with floor sensor enabled) will be shown in the display.



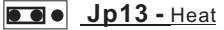
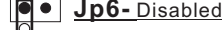
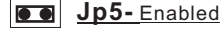

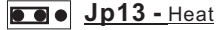
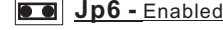
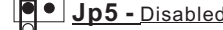

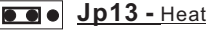
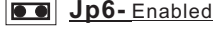
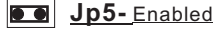

**NB. Ex-factory mode is Room + Floor limitation.**

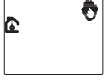
### Jumper Settings:

<b>1. Room mode</b>  Heat  <b>Jp13 - Heat</b>  <b>Jp6 - Disabled</b>  <b>Jp5 - Enabled</b>	<b>2. Floor mode</b>  Heat  <b>Jp13 - Heat</b>  <b>Jp6 - Enabled</b>  <b>Jp5 - Disabled</b>	<b>3. Room + Floor mode</b>  Heat  <b>Jp13 - Heat</b>  <b>Jp6 - Enabled</b>  <b>Jp5 - Enabled</b>
---	---	---

### Display shows:

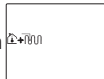
<b>1. Room mode</b>  System ON  System OFF 	<b>2. Floor mode</b>  System ON  System OFF 	<b>3. Room + Floor mode</b>  System ON  System OFF 
--	---	--

## E. SET/MODIFY THE 'INTERNAL SETTINGS'

In order to select the maximum floor temperature, it's recommended to check with your flooring supplier. For vinyl and wood flooring this is normally  $\pm 28^{\circ}\text{C}$ .

Default settings can be found on the "SPECIFICATIONS" page 4; we suggest you read the information thoroughly before setting/adjusting these values.

### Front panel

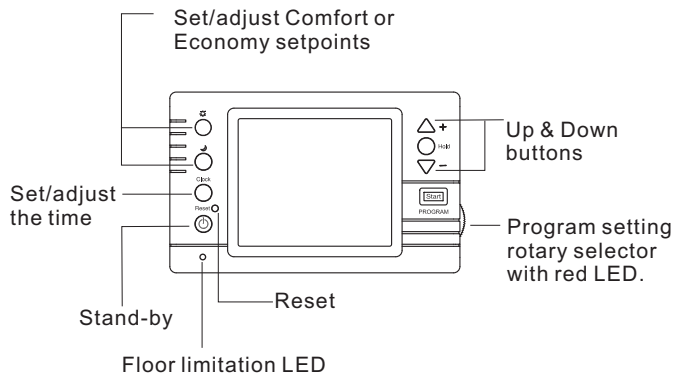

It is advisable to press "RESET" before changing the Internal Settings.

Consult with a technician if uncertain on the choice of the best operating mode.

**To enter the setting mode, ensure the rotary switch is set to "Start"!**



### Room mode

1. Press  $\Delta+$  and  $\nabla-$  simultaneously for 5 seconds to enter the setting mode.
2. Press  $\Delta+$  or  $\nabla-$  to set  $^{\circ}\text{C}$  or  $^{\circ}\text{F}$ .
3. Press  $\odot$  to set the switching differential.
4. Press  $\Delta+$  or  $\nabla-$  to set the switching differential.
5. Press the  $\odot$  button to return to operate mode.

### Note:

A 3 minute waiting time will be required for the thermostat to start its operation after installation if 'Cool' mode was selected.

This waiting time will not be required in 'Heat' mode.



### Floor mode (Floor heating only!)

1. Press  $\Delta+$  and  $\nabla-$  simultaneously for 5 seconds to enter the setting mode.
2. Press  $\Delta+$  or  $\nabla-$  set  $^{\circ}\text{C}$  (Celsius) or  $^{\circ}\text{F}$  (Fahrenheit).
3. Press  $\odot$  for the next setting – Hi temperature limit (The floor heating will be turned off when the floor temperature reaches the Hi limit.)
4. Press  $\Delta+$  or  $\nabla-$  to set the Hi limit.
5. Press  $\odot$  – Lo limit (The heating will be turned on when the floor temperature drops below this Lo limit.)
6. Press  $\Delta+$  or  $\nabla-$  to set the Lo limit.
7. Press  $\odot$  – Switching differential (Hysteresis).
8. Press  $\Delta+$  or  $\nabla-$  to set the switching differential.
9. Press  $\odot$  to return to operate mode.

### Room + Floor limitation mode (Floor heating only!)

1. Press  $\Delta+$  and  $\nabla-$  simultaneously for 5 seconds to enter the setting mode.
2. Press  $\Delta+$  or  $\nabla-$  to set  $^{\circ}\text{C}$  (Celsius) or  $^{\circ}\text{F}$  (Fahrenheit).
3. Press  $\odot$  to set the next setting – Hi limit. (The floor heating will be turned off when the floor temperature reaches the Hi limit.)
4. Press  $\Delta+$  or  $\nabla-$  to set the Hi limit.
5. Press  $\odot$  switching differential (Hysteresis)
6. Press  $\Delta+$  or  $\nabla-$  to set the switching differential.
7. Press  $\odot$  to return to operate mode.

## F. SET/ADJUST THE CLOCK

1. Press  $\odot^{\text{Clock}}$
2. Press  $\Delta+$  or  $\nabla-$  to set the day of week.
3. Press  $\odot^{\text{Clock}}$  for hour.
4. Press  $\Delta+$  or  $\nabla-$  to set the hour of the day.
5. Press  $\odot^{\text{Clock}}$  for minutes.
6. Press  $\Delta+$  or  $\nabla-$  to set the minutes.
7. Wait 5 seconds, the unit will automatically retain the time and start operation.

## G. SET/ADJUST THE REQUIRED SETPOINTS FOR COMFORT AND ECONOMY

The selected COMFORT or ECONOMY setpoints will operate in each of 48-programming-sections in a day.

1. Press  $\odot^*$
2. Press  $\Delta+$  or  $\nabla-$  to select the temperature setpoint for COMFORT.
3. Press  $\odot^{\text{Clock}}$
4. Press  $\Delta+$  or  $\nabla-$  to select the temperature setpoint for ECONOMY.

5. Wait 5 seconds, the unit will automatically retain the settings and start operation.

**NB.**

In Floor mode, the COMFORT setpoint cannot be set above the "Hi Limit" and the ECONOMY setpoint cannot be set lower than the "Lo Limit".

**In Room+Floor limitation mode, the COMFORT setpoint cannot be set above the "Hi limit".**



**H. SET/ADJUST THE PROGRAMMING**

Set/Adjust COMFORT or ECONOMY setpoints in each of 48 programming-sections of a day and all 7 days of a week.

1. Spin the rotary selector to the desired day of the week and start programming.
2. Press or to alter the settings between and on the display.
3. Press or to select each required programming section. LCD display will indicate each programming section by digital numbers and flashing display.
4. After completing the programming for all 7-days, spin the rotary selector to "START" to start operating.

**Note:**

If the rotary-selector is left at any setting other than "Start" for more than 1 minute during programming the LCD will show:

In such case, spin rotary selector to Start and restart the programming.

**Built-in program default settings**

**Monday ~ Friday**

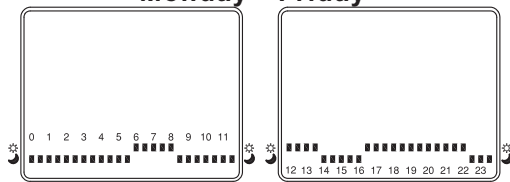

**Saturday ~ Sunday**

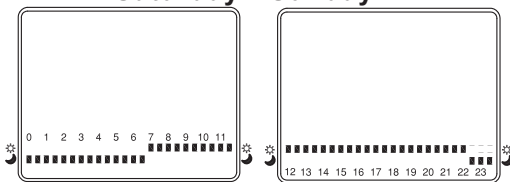

Room mode(Heat)  
Room+Floor Limit

= 21°C

= 16°C

Floor mode

= 26°C

= 21°C

**I. PROGRAM OVERRIDES**

**Manual (Temporary Override)**

When the unit is in operation, users can increase or decrease the temperature setpoint by pressing the or -buttons.

Wait 5 seconds after changing the setpoint and the unit will automatically retain the setting and start to run the "Manual" function. The flashing symbol will show on the display to indicate the Manual function(Temporary Override) is active.

This function will not alter the Comfort or Economy setpoints.

While the unit is operating the "Manual" function; rotating the rotary selector away from "Start" and back will abort the "Manual" function and the normal program will resume.

When in Comfort while activating the Manual function the thermostat will continue to operate in Manual until the program switches to Economy and vice versa.

The and icons will disappear from the LCD while the Manual function is active.

**Stand-by**

When the unit is in operation, users can manually turn the thermostat's operation ON or OFF.

1. Press
2. Wait 5 seconds, the thermostat will manually turn off its operation.
3. Press again the will turn on the thermostat's operation.

**Anti-frost protection will automatically be activated when the unit is operating in Stand-by.**

**Hold**

When the unit is in operation (The rotary selector is at "Start") users can maintain the temperature at a fixed setpoint.

1. Press
2. Press or to set the required setpoint.
3. Wait 5 seconds and the unit will automatically retain the temperature setting and start to operate
4. While the unit is operating in "Hold", pressing the will stop the "Hold" function and resume the normal program.

**Auto resume**

Auto resume the programming's operation and stop operating in Stand-by mode.

1. Press
2. Press to select the required day within the next 7-days to automatically resume it's normal operation.
3. Wait 5 seconds and the unit will automatically operate this function. On the LCD it will display:

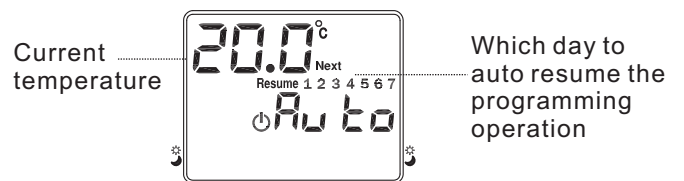

4. When this function is in operation, pressing the will immediately resume normal program operation.

**Anti-frost protection will automatically be activated when the unit is operating the Auto Resume function. If you are going to be away longer than 7 days, use the stand-by function.**

**Reset to factory default settings**

To set the program back to the factory default settings:

1. Spin rotary selector to "START"
2. Press and hold the button for 5 seconds.
3. On the LCD will appear.
4. Press the button.

The thermostat has now reverted back to the factory default settings.

**J. CONNECTION DIAGRAMS**



**Disconnect the mains before you start wiring!**

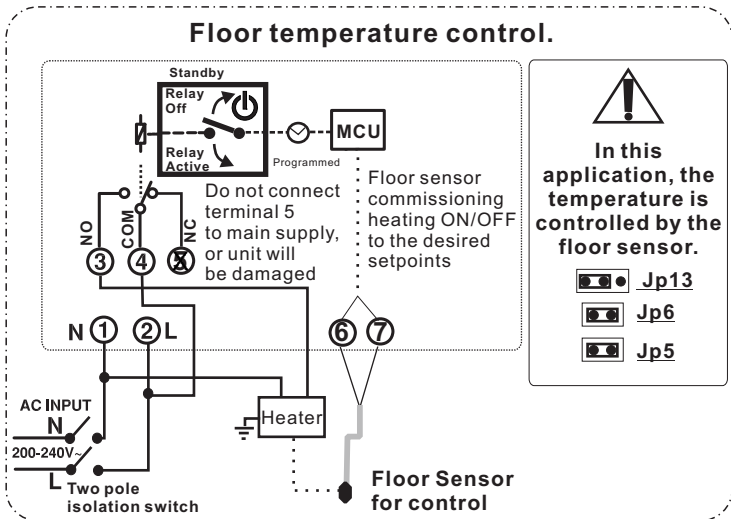
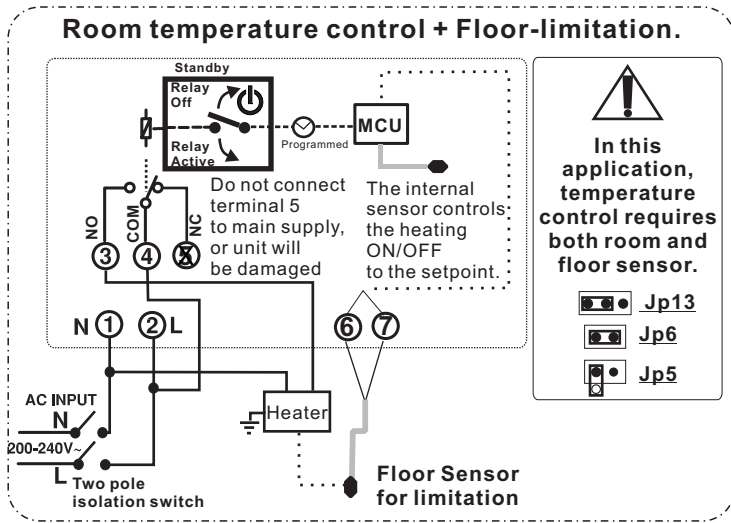
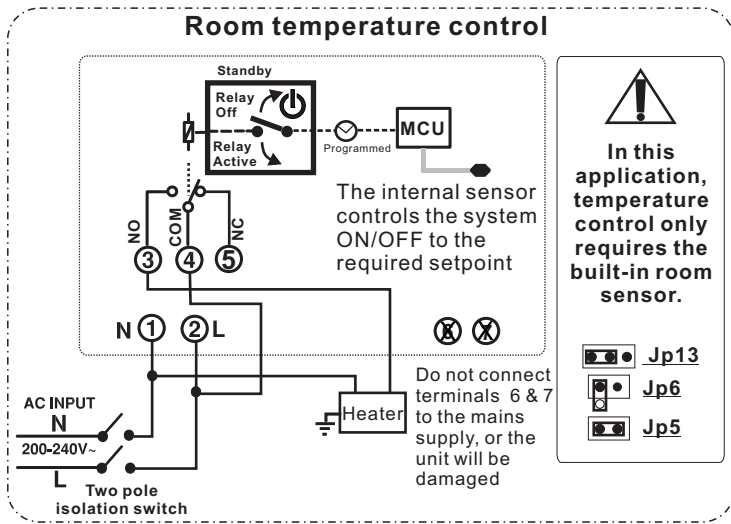

## K. SPECIFICATIONS

- Operating voltage : 230 Vac  $\pm$  10%, 50 ~ 60Hz
- Display: Colour change LCD back light changing from blue (cold) to red (hot) depending on the temperature..
- Output: Voltage-free contact, Rating 16 Amp/ 250Vac
- Circuitry consumption: 8VA
- Temperature indication:  $^{\circ}$ C or  $^{\circ}$ F selectable.
- Temperature control range: Room: 5 ~ 35 $^{\circ}$ C  
Floor: 5 ~ 45 $^{\circ}$ C 0.5 $^{\circ}$ C/step
- Temperature Display Range:  $\pm$  -10 ~ 50 $^{\circ}$ C), resolution: 0.1 $^{\circ}$ C.
- Comfort & Economy setpoint range:

- Room: 5 ~ 35 $^{\circ}$ C Floor: 5 ~ 45 $^{\circ}$ C 0.5 $^{\circ}$ C/step  
Default settings-- Floor-mode: 26 $^{\circ}$ C.  
Room mode (Heating) & Room+Floor Limitation mode : 21 $^{\circ}$ C  
Room mode (Cooling) : 24 $^{\circ}$ C
- Room: 5 ~ 35 $^{\circ}$ C Floor: 5 ~ 45 $^{\circ}$ C 0.5 $^{\circ}$ C/step  
Default settings-- Floor-mode: 21 $^{\circ}$ C  
Room mode (Heating) & Room+Floor Limitation mode: 16 $^{\circ}$ C  
Room mode (Cooling) : 27 $^{\circ}$ C

- Floor temperature limitation setpoint range:  
For Floor mode or Room+Floor-limitation mode only:  
Hi Limit.: 20 ~ 45 $^{\circ}$ C (default setting 29 $^{\circ}$ C)  
Lo Limit.: 5 ~ 20 $^{\circ}$ C (default setting 15 $^{\circ}$ C)  
\*In Floor-mode, the Lo limit acts as low-temperature protection, the Hi-Limit acts as maximum floor-temperature limitation.  
\*In Room+Floor Limitation mode, only the the Hi-Limit is in effect.
- Temperature sensor : NTC 10k Ohm at 25 $^{\circ}$ C, same on both Room-sensor & Floor-sensor
- Switching differential (Hysteresis) selectable by the user:  
In Room mode (Mode 1): 0.2/0.4/0.6/ 0.8 /1 $^{\circ}$ C , default setting 0.4 $^{\circ}$ C  
In Floor mode (Mode 2) : 0.6 $^{\circ}$ C/ 1 $^{\circ}$ C/2 $^{\circ}$ C/3 $^{\circ}$ C, default setting 1 $^{\circ}$ C  
In Room+Floor limitation mode (Mode 3) : The same hysteresis value as in Room mode applies
- Floor-limitation switching differential: 2.0  $^{\circ}$ C fixed, not adjustable.
- Programming : 7d. Each one of the 7 days in a week is independently programmable. Each day is split into 48 time periods of 30 minutes. In each of these time periods the COMFORT or ECONOMY temperature may be chosen as the setpoint. Both 24H/12H clock formats are available. The default setting is : 24H
- Stand-By : To manually turn off the thermostat's operation. (Internal clock & program keep running)
- Auto resume : Stop the Stand-by operation and resume the thermostat's program operation on the selected day within the following 7 days.
- Anti-frost protection: Prefixed, not adjustable. In effects when thermostat is in Stand-by ()function. Room-mode or Room+Floor limitation Mode + 5 $^{\circ}$ C. Floor Mode + 10 $^{\circ}$ C)
- Factory default internal settings & programming default settings on Reset.
- Non-volatile EEPROM to retain the program.
- Cr2032 Lithium battery for maintaining the time during power outages.
- Red LED indicator on the rotary programming selector.
- Green LED indicates the operating status of the floor limitation.
- Storage temperature : -10 ~ 60 $^{\circ}$ C.
- Dimensions: (WxHxD) 138 x 86 x 33.1 mm

## L. CONTENTS

- Thermostat (incl. CR2032 backup battery)
- Instruction sheet
- Machine screws (2)
- Anchors plugs (2)
- Self-tapping screws (2)

- Floor sensor and cable (optional)  
(10kOhm @ 25 $^{\circ}$ C - 4 metres)

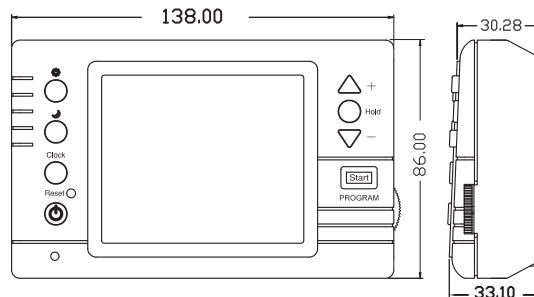

Klimax Manufacturing Ltd.  
222 Van Dyk Road,  
Boksburg, South Africa

Proheat Help Line:  
**0860 554 629**  
www.proheat.co.za